

Precision Machined & Cold Headed Fasteners

- ▶ Wide variety of stock and custom fasteners, to any volume
- ▶ Industry-specific NAS fasteners
- ▶ ISO 9001 & AS9100 certified



MW Components
Fasteners

The MW Components Difference

Get to Market Faster

Take advantage of our in-house experts' design for manufacturability skills to improve your part's performance while reducing production time and cost.

- » Prototyping
- » Millions of standard parts in-stock
- » Quick turn manufacturing and JIT delivery

Optimize Your Design

Use our inventory and established processes to get your product to market faster. We ship stock parts the same-day and can expedite custom orders to support R&D and full-scale production.

- » 100+ design engineers
- » 4,000+ manufacturing experts
- » Reduce unnecessary costs and time

Simplify Your Processes

Streamline your supply chain and safeguard your production. With 20+ locations nationwide and financial stability, we have the capacity and security to support your projects.

- » One-stop shop for components
- » Concierge-level service and inventory management
- » USA-made, private equity funded

➤ MW Components Products - Stock, Standard, and Custom

Springs



Coiled, flat, and machined springs (including compression, extension, and torsion springs)

Fasteners



Nuts, bolts, screws, rivets, cotter pins, threaded inserts, bushings, studs, and washers

Precision Components



Metal bellows, shims, wire forms, electrical contacts, electroforms, pins, and couplings

25+ Manufacturing Locations Across the US

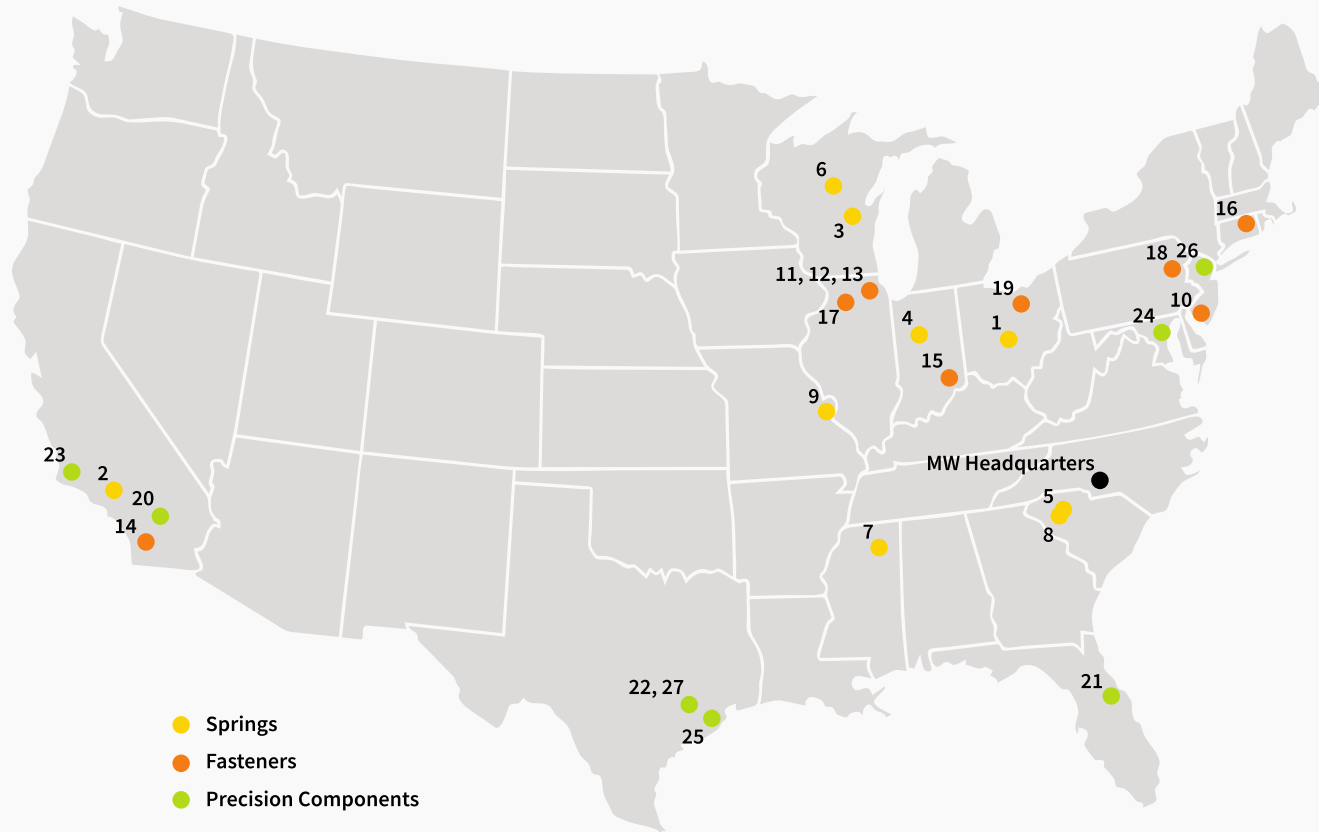

The World's Largest Range of Precision Components

Springs

- 1 Capital Spring
- 2 Century Spring
- 3 Fox Valley Spring
- 4 Matthew Warren Spring
- 5 MW Components: Greer
- 6 Northern Wire
- 7 Pontotoc Spring
- 8 Springmasters
- 9 Western Wire Products

Fasteners

- 10 Accurate Screw Machine
- 11 Allstar Fasteners
- 12 Hi-Performance
- 13 Holbrook Manufacturing
- 14 Ideal Fasteners
- 15 Ohio Rod Fasteners
- 16 RAF Electronic Hardware
- 17 Rockford Fastener
- 18 Sussex Wire
- 19 Telefast Industries

Precision Components

- 20 Ameriflex
- 21 BellowsTech
- 22 Engineered Spring Products
- 23 Helical Products
- 24 Maryland Precision Spring
- 25 Maudlin
- 26 Servometer
- 27 USA Fastener

➤ **Your comprehensive solution for precision machined and cold headed fasteners, from design optimization to production**

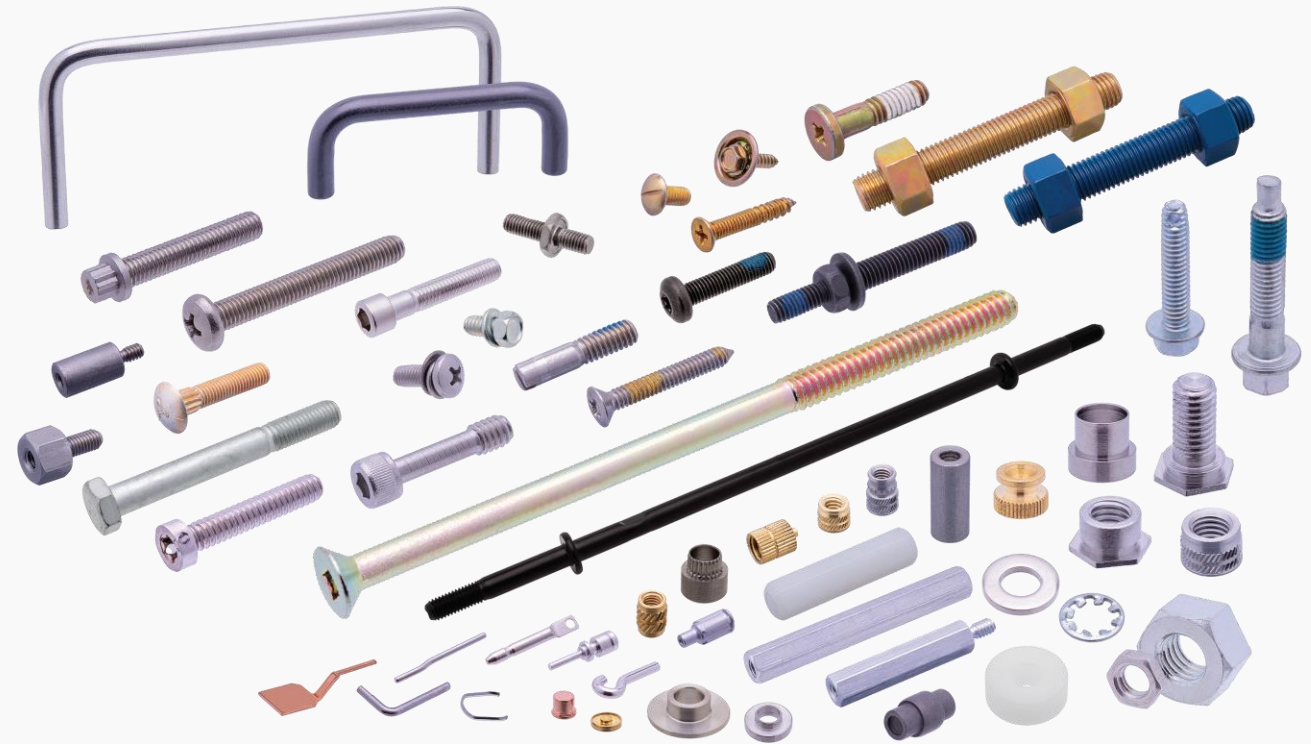

Expertise & Support At Any Point In Your Product's Lifecycle

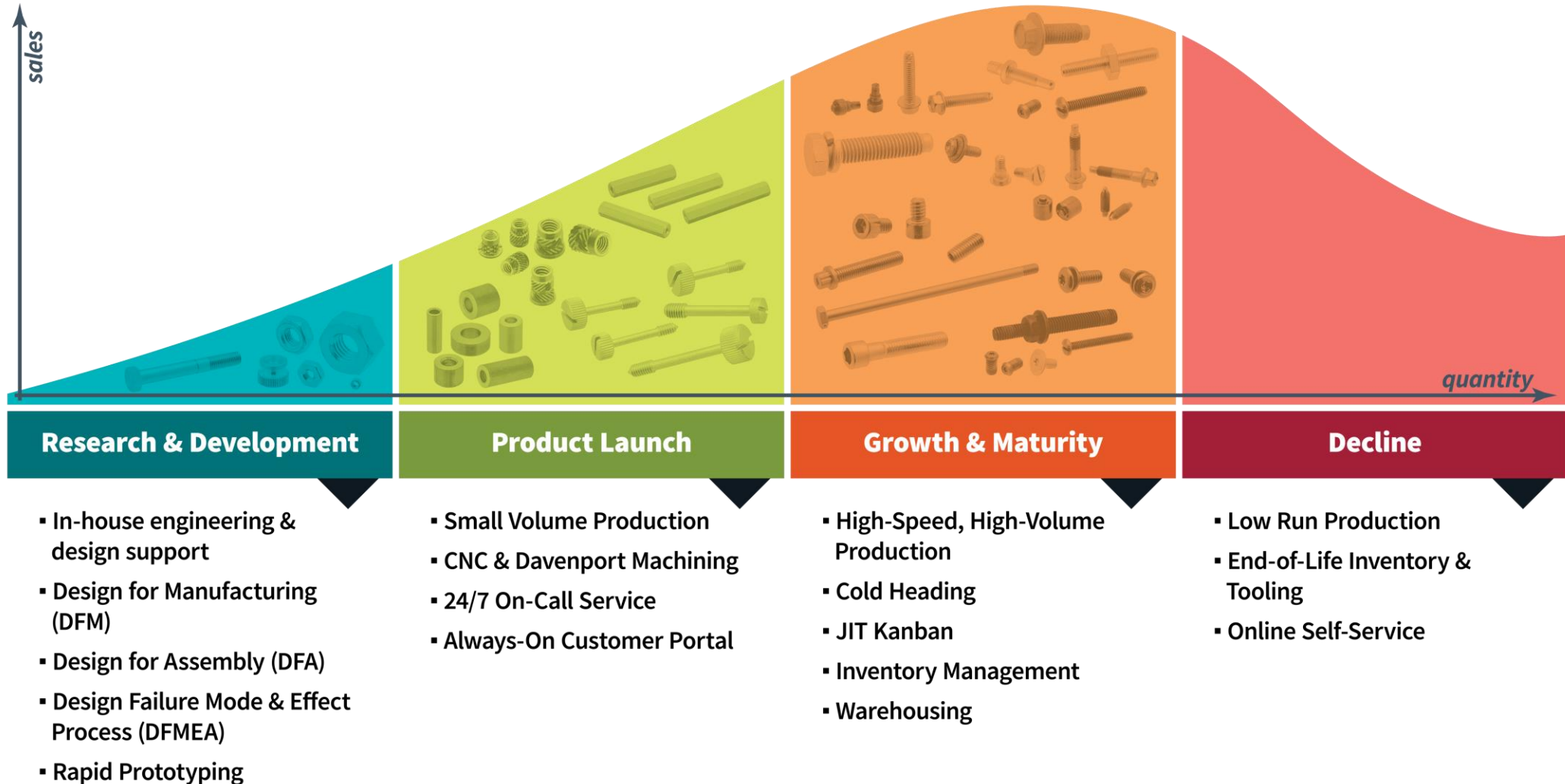

Extensive Network Of Fasteners Locations



Accurate Screw Machine



Allstar Fasteners



Hi-Performance



Holbrook Manufacturing



Ideal Fasteners



Ohio Rod Products



RAF Electronic Hardware



Rockford Fastener



Sussex Wire



Telefast Industries



USA Fastener



Western Wire

Fasteners Manufacturing Locations

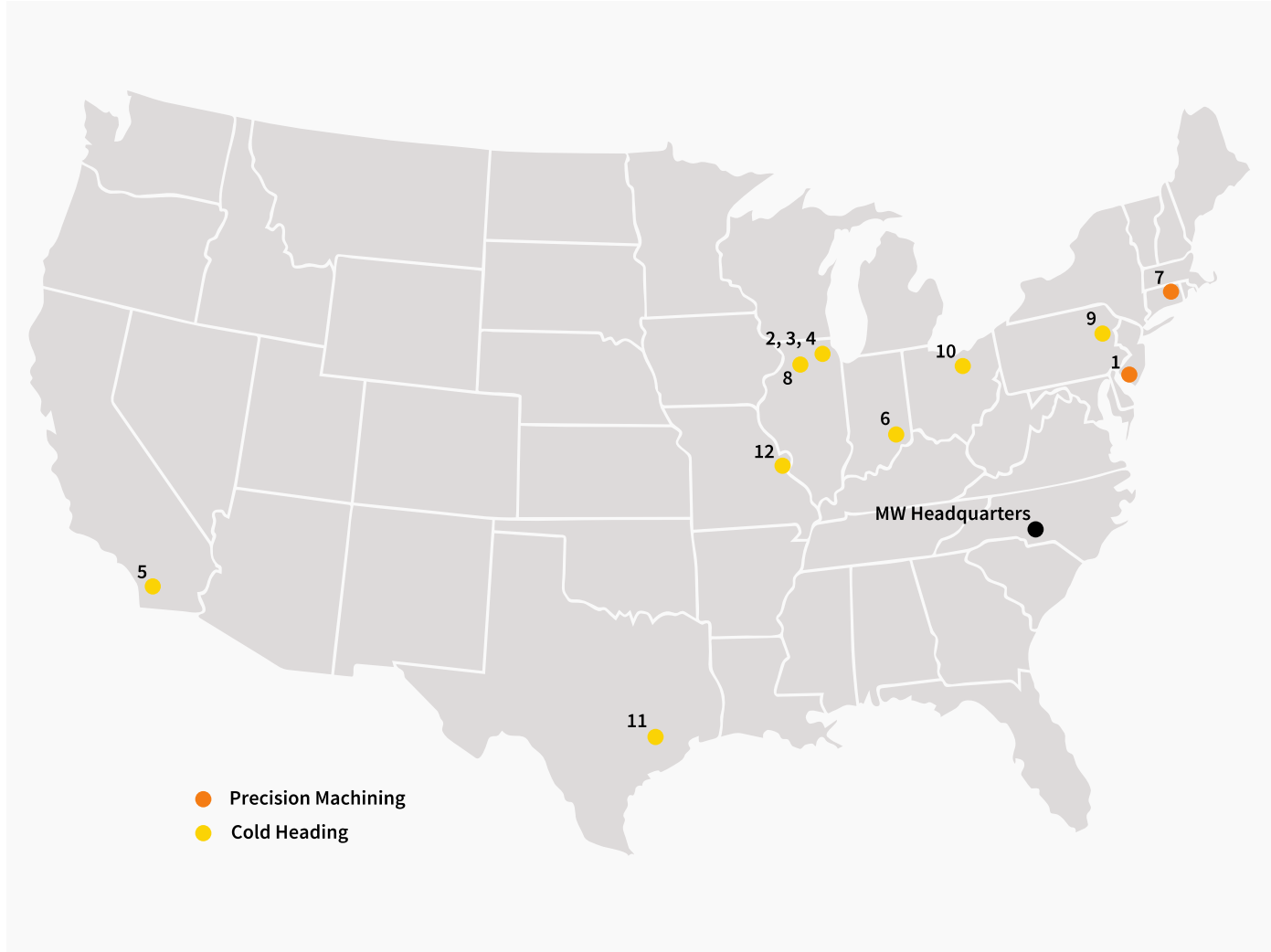

MW Components offers one of the world's largest ranges of precision machined and cold headed fasteners through our extensive network of fasteners locations across the US.

1. Accurate Screw Machine
2. Allstar Fasteners
3. Hi-Performance
4. Holbrook Manufacturing*
5. Ideal Fasteners
6. Ohio Rod Products*
7. RAF Electronic Hardware
8. Rockford Fastener*
9. Sussex Wire
10. Telefast Industries*
11. USA Fastener
12. Western Wire

* Added Through Elgin Fastener Group Acquisition



Elgin Fastener Group Capabilities At A Glance

	Holbrook Manufacturing	Telefast Industries	Rockford Fastener	Ohio Rod Products
	Cold Formed Products			Specialty
Bolts	✓	✓	✓	✓
Long Rods				✓
Nuts		✓		
Rivets		✓	✓	✓
Screws	✓	✓	✓	
Studs & Pins	✓	✓	✓	✓
Wire Forms				✓

➤ Stock & Custom Parts Delivered When & Where You Need Them

- Stock Parts Ship Same Day
- Custom Parts Ship Within 1 Week
- Metric & Standard Sizes
- Large Selection of Heads, Threads, Lengths, ID's & OD's
- High & Low Volumes
- Quality Certifications Including ISO 9001, AS9100

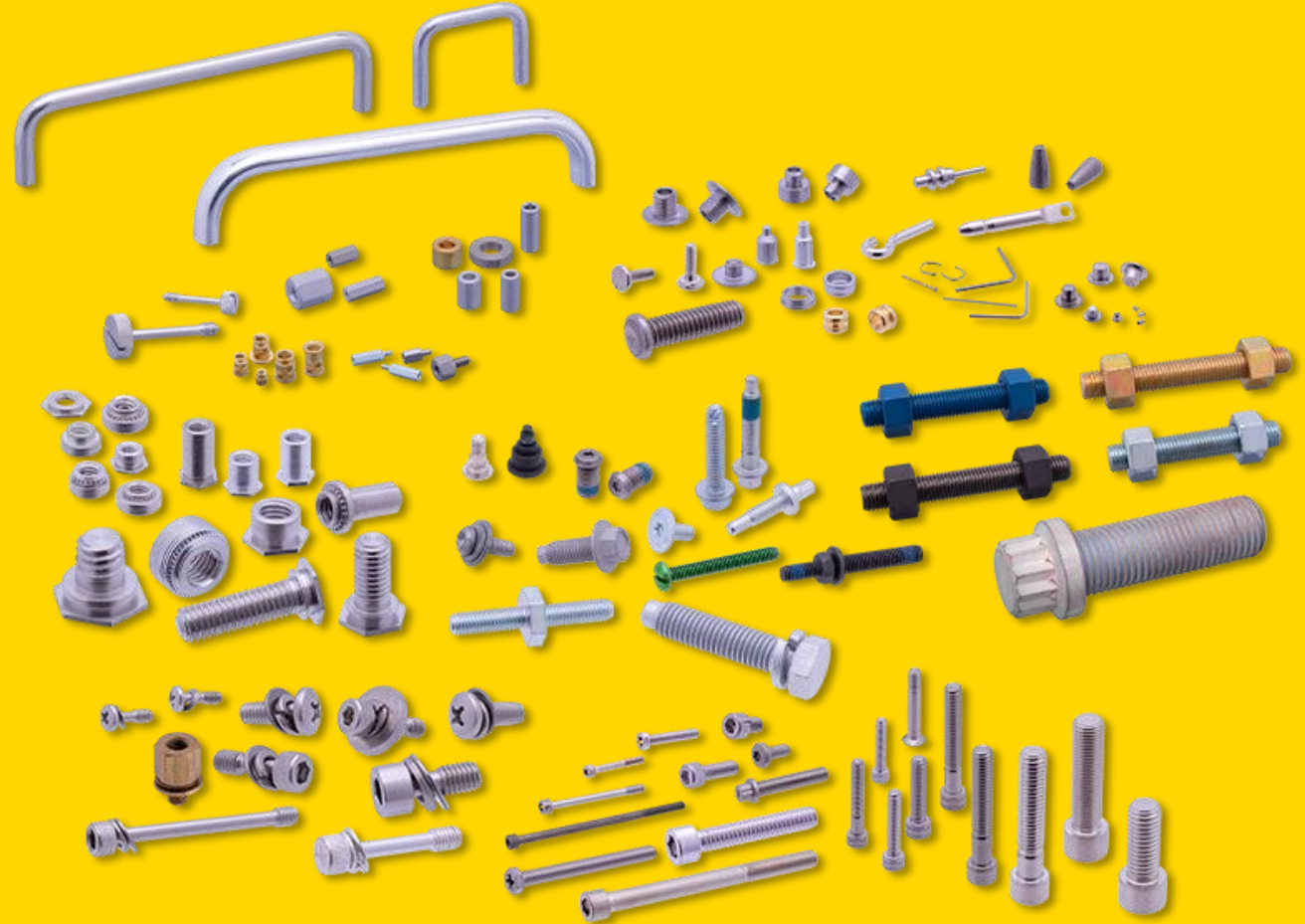

➤ Stock & Custom Products

We manufacture a wide variety high-quality fasteners and metal components, at high and low volumes, in a range of sizes and alloys.



Screws & Screw Assemblies (SEMs)



Bushings / Spacers



Threaded Inserts



Standoffs



Washers



API B7 Studs & Nuts



NAS / MS Fasteners

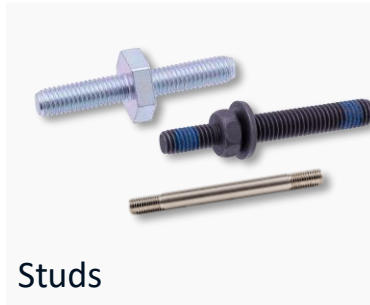

Studs



All Thread Rods



Nuts



Retainers



Wire Forms & Pins



Handles / Ferrules

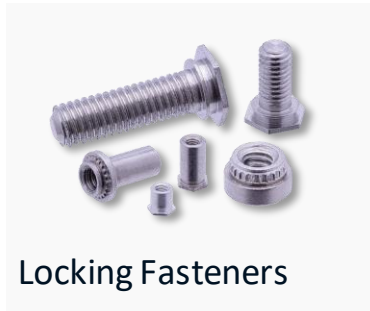

Locking Fasteners



Rivets



Bolts

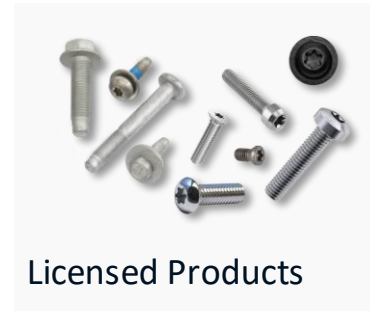

Licensed Products



Micro Components

➤ Licensed Products

Drive Types



TORX®, TORX PLUS®, ACR
PHILLIPS II®, PHILLIPS
SQUAR-DRIV®

Thread Technology



LO-DRIV®, TAPTITE II®,
DUO-TAPTITE®, PLASTITE®,
REMFORM II®, FASTITE®

Starting Technology



TRU-START®, MATpoint®,
MAThread®

➤ Custom / Specialty Fasteners

High-precision Custom Manufacturing To Meet Tight Tolerances

We provide custom print-to-part manufacturing using our state-of-the-art equipment, which allows for the machining of specialty materials and tight tolerances to create precisely the specialty fastener you need.

- Expert Design Support
- Cad-on-demand, 3D Images & Drawings
- Prototyping & Rapid Prototyping
- Standard, Exotic & Specialty Materials
- Finishing Services
- Print-to-part Typically In 1 Week Or Less



➤ In-House Engineering Services & Production Processes

In-house Tooling And CNC-controlled Processes To Deliver Parts To Exacting Tolerances, Every Time

Our experienced team of experts works with you to create, refine, and optimize designs to your specific tolerances, performance requirements, and use cases.



Engineering Services Include:

- CAD Modeling
- Rapid Prototyping
- Fatigue Testing
- Metallurgy
- Performance Analysis
- CAE Analysis
- 3D Printing
- Corrosion Analysis & More

Production Processes Include:

- Cold Heading / Cold Forming
- Thread Rolling
- SEMS Rolling
- Head & Shank Slotting
- Trimming
- Heat Treatment
- Hardening
- Annealing & More

➤ Cold Heading

Meet Critical Functional Specifications Without Compromise To Design For Manufacture (DFM), Design For Assembly (DFA), Quality And Cost

- Produces 90-300 Parts/Minute
- Up To 70% Cost Reduction With Low To No Scrap
- Average Time To Market, Approximately 12 Weeks
- Efficient At High Runs In The Millions Of Pieces
- Ideal For Small Metal Parts, Including Micro Electronic Components, Micro Contacts & More

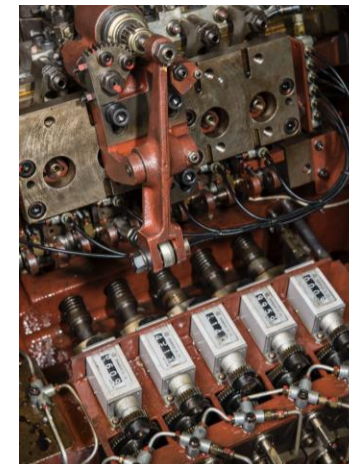
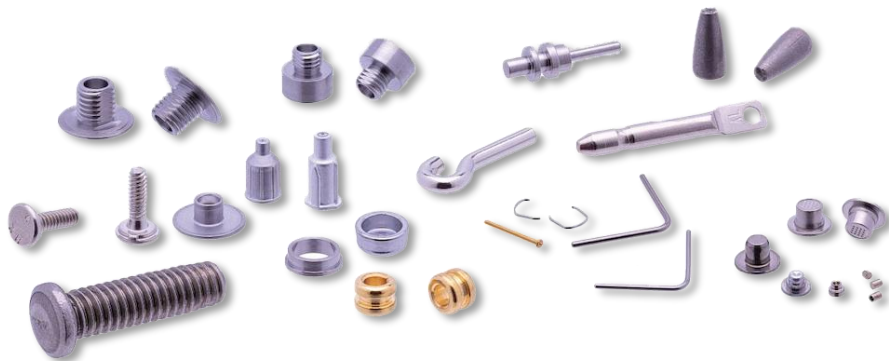

➤ Machining

Get Precision-machined Parts Tailored To Your Needs, Meeting High Strength, High Quality, And Precision Tolerance Specifications

- Produces 30-40 Parts/Minute
- Zero To Low Upfront Tooling Cost
- Rapid Time To Market, Less Than 4 Weeks
- Efficient Runs Under 100,000 Pieces
- Prototyping Capabilities - Delivery In Less Than 1 Week

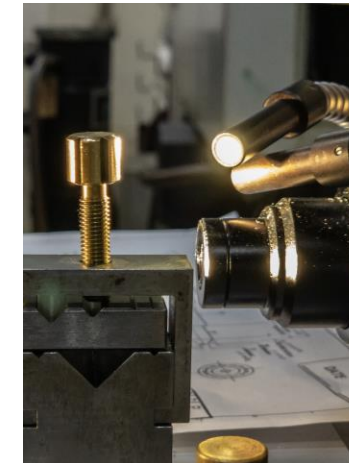

Quality Certifications

Get The Quality You Demand

Our commitment to quality runs throughout our facilities which are accredited across multiple quality management systems.



- ISO 9001
- AS9100D
- ITAR
- IATF 16949
- MIL-I-45208A
- MIL-STD-45622
- MIL-C-39029
- QSLM Class 2 & 3
- NADCAP Accredited
- ANAB Accredited
- REACH Compliant
- RoHS Compliant
- DFARS Compliant
- AMS Compliant
- FQA Compliant
- NIST Traceability
- API 14 A&D
- Prop65 Compliant

➤ Broad Industry Experience



- Aerospace
- Agriculture
- Automotive
- Electronics
- Heavy Construction
- Energy, Oil & Gas
- Heavy Truck & Bus
- Medical
- Defense
- Motorsports & Racing
- Power Tools
- Transportation
- Valves
- Semiconductor
- Consumer Goods



Fastener Products & Capabilities By Location

➤ Accurate Screw Machine

Your #1 Source for Fasteners, Electronic Hardware, and Custom Parts

- Quote Turnaround in 24hrs
- Stock Parts Ship Same Day
- Flexible Minimum Order Quantities
- Fast Delivery Of Custom Parts
- CNC Precision Machining
- ISO 9001 & AS9100 Certified

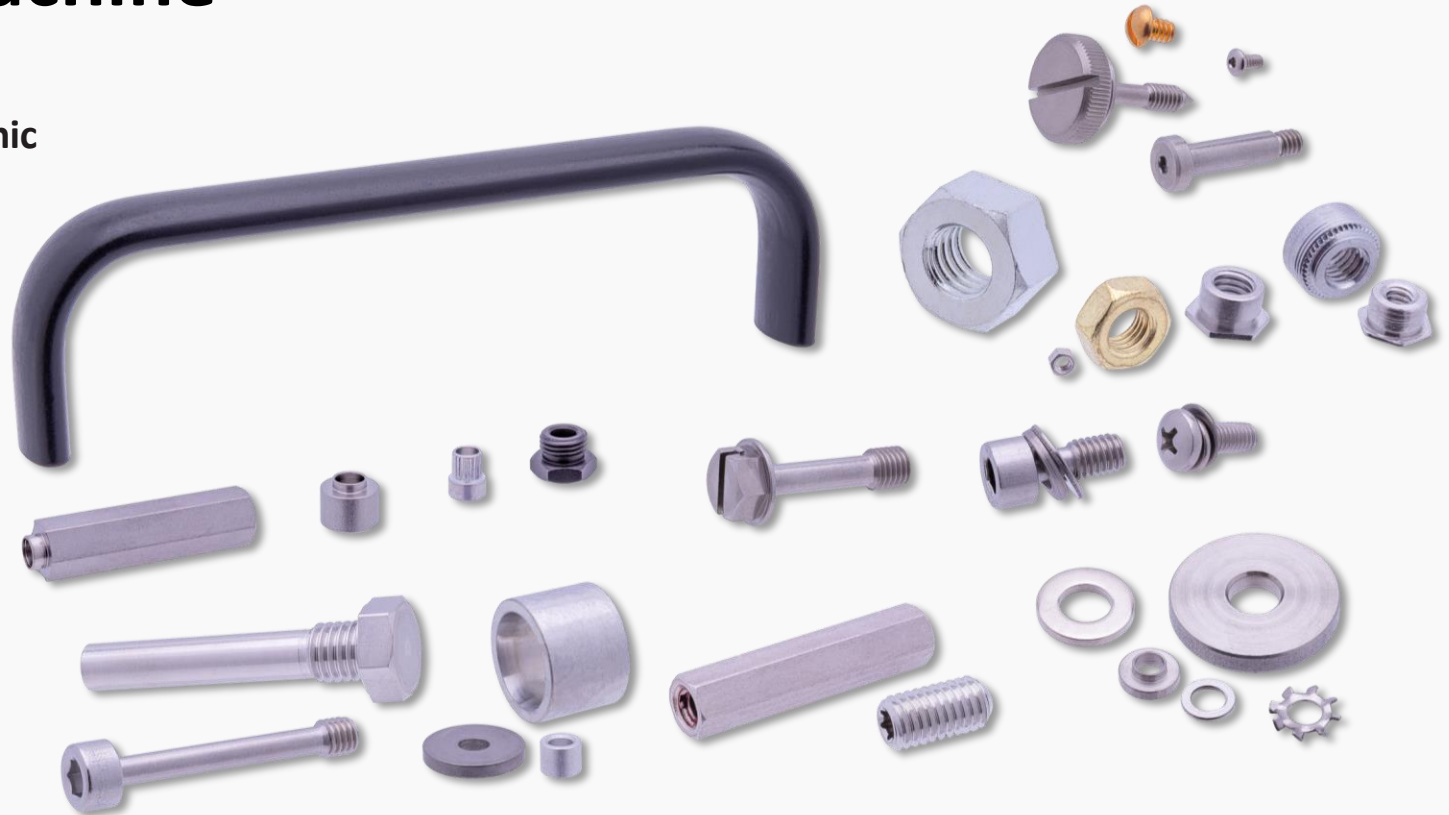

➤ Accurate Screw Machine Products

Screws



Captive Screws & Assemblies

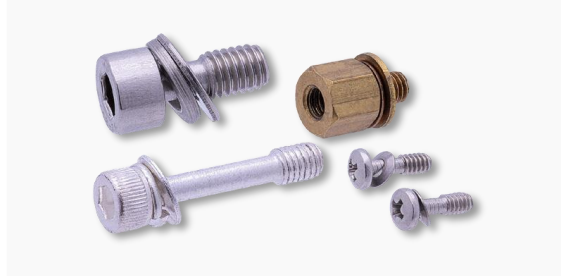

Bushings / Spacers



Standoffs

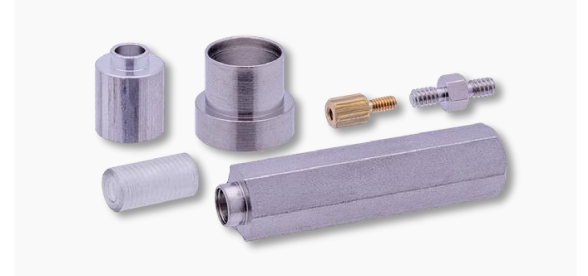

Locking Fasteners



Washers



Nuts



Handles



Custom / Precision Machined



Custom Machining

Speed and precision matter. Accurate Screw Machine's precision fastener components are tailored to your specific needs with fast delivery, including custom screws.

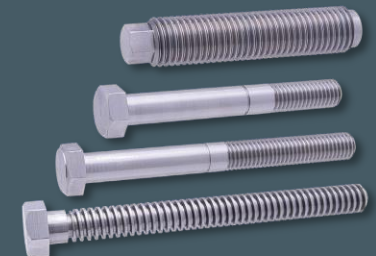



Accurate Screw Machine Process Capabilities

Diameters	• Available in all types of diameters both US and Metric	
Lengths	• Available in all types of lengths both US and Metric	
Materials	• A286, Stainless Steel-all grades, Al, Brass, Nickel, Super Alloys, Cu, Steel (Carbon & Alloy), Exotics, Plastics	
Threads	• Customizable to all machined thread sizes both US and Metric	
Finishes	• Passivation • Anodized	• Black Ox • Chem-Film
Plating	• Cadmium • Chromium • Nickel	• Silver • Tin • Zinc
Locking Devices	• Patch & Vibra-Tite (internal/external) • Pellet	• Strip
Manufacturing Processes	• CNC Screw Machining • Mill/Turn • Tapping	• Sawing • Center-less Grinding
Additional Processes	• NADCAP • Heat Treat	• Assembly
Certifications	• AS9100D • ISO 9001:2015 • ITAR • DFARS	• REACH • RoHSCage Code: 51506 • Unique Entity ID (UEI): Available on SAM.gov

Markets Served

- Aerospace
- Electronics
- Department of Defense
- Industrial
- Commercial

Get In Touch

To order stock or custom parts, visit accuratescrew.com or contact us at 973.244.9200 | sales@accuratescrew.com

➤ Allstar Fasteners

Your Choice for Stock & Custom Cold Headed Fasteners

- Fast Delivery Of Stock & Custom Parts
- Large Selection Of Drive Styles & Thread Types
- Flexible Minimum Order Quantities
- Stock & Release Programs
- ISO 9001 Certified



➤ Allstar Products

Sheet Metal/Self Tapping Products



Machine Screws



Thread Cutting Products



Thread Forming Products



Shoulder Screws



Trimmed Head & T-Bolts



Locking Patches & Adhesives



Knurled & Ribbed Products



Tamper Resistant Products



SEMs & Washer Assemblies



Serrated Products



Socket Products



Allstar Fasteners Process Capabilities

Diameters	<ul style="list-style-type: none"> Standard: #1 – 3/8" Metric: M2 – M10
Lengths	<ul style="list-style-type: none"> Standard: 1/8" – 3-1/4" Metric: 3mm - 83mm
Materials	<ul style="list-style-type: none"> Steel - 1008, 1010, 1016, 1018, 10B21, 1022, 1038, Stainless Steel – 302, 316, 410, 430, Brass, Silicon Bronze, Aluminum, Copper
Head Styles	<ul style="list-style-type: none"> Pan, Flat, Flat U/C, 100° Flat, 90° Flat, Round, Truss, Indented Hex, Indented Hex Washer, Trimmed Hex, Button, Binder, Binder U/C, Oval, Oval U/C, 100° Oval, 90° Oval, Indented Square, Trimmed Square, Custom Design
Drive Styles	<ul style="list-style-type: none"> Phillips (I), Pozi (1a), Frearson (II), Six Lobe, Torx, Six Lobe Plus, Torx Plus, Six Lobe w/ Pin, Torx w/ Pin, One-Way Slotted, Triwing, Square, and any combination of the above drives
Manufacturing Processes	<ul style="list-style-type: none"> Heading Threading Head Slotting Shaving Trimming Pinch Pointing Centerless Grinding Drilling & Tapping Electronic Sorting Roll Sorting Kitting
Additional Services	<ul style="list-style-type: none"> Heat Treating/Annealing Electroplating Coating Painting Patching
Certifications	<ul style="list-style-type: none"> ISO 9001 RoHS Compliant REACH Compliant Prop65 Compliant Conflict Minerals DFARs- as requested PPAP and ISIR - as requested Stock & Release Programs / Vendor Managed Inventory Available

Markets Served

- Agriculture
- Electronics
- Heavy Trucks & Bus
- Automotive
- Heavy Construction
- Power Tools

Get In Touch

To order stock or custom parts, visit AllStarFasteners.com or contact us at 847.640.7827 | allstarsales@iwic.net

➤ Hi-Performance

Specialty Cold Headed Fasteners and Assemblies

- Licensed MATHread®, Phillips II® Drive Systems & TORX® Drive Systems Supplier
- Multi-Die & SEMs Products
- Quick Quote Turnaround
- Fast Delivery Of Custom Parts
- ISO 9001 Certified



Hi-Performance Products

Licensed MATHread® Supplier



Phillips II® Drive Systems



Licensed TORX® Drive Systems



SEMs Products



Multi-Die Products



Weld Screws & Weld Pins



Thread Forming Products – Plastics



Solid Body Rivets



Thread-Locking Products



Tri-Lobular Thread Forming Products - Metals



Custom Engineered Products



Hi- Performance Process Capabilities

Diameters	<ul style="list-style-type: none"> Metric: M2.2 - M12 American: #2 - 1/2"
Lengths	<ul style="list-style-type: none"> Metric: 6mm - 100mm American: 0.250" - 4.00"
Materials	<ul style="list-style-type: none"> Carbon Steel: 1010 1018, 10B21, 1022, 10B30, 1035, 1038, 1524, 1541 Alloy Steel: 4037, 4140 Stainless Steel: 302, 304, 316, 410, 430, A286 Specialty: Brass, Silicon Bronze, Aluminum, Copper
Manufacturing Process	<ul style="list-style-type: none"> Heading (Single & Multi-Die) Rolling (SEMs & Non-SEMs) Roll Forming Slotting (Shank & Head) Trimming Shaving Grinding Pointing Drilling Tapping Turning Broaching Burnishing
Sorting	<ul style="list-style-type: none"> Camera Systems Optic Systems Eddy-Current Technology Mechanical Roller Manual
Additional Processes	<ul style="list-style-type: none"> Heat Treating (Neutral/Through, Case, Induction) Platings (Electroplate, Mechanical) Coatings/Paints (Conversion, E-Coat, Dip-Spin) Adhesives Patches Thread Sealers Retention Features & Designs Over-Mold Designs Component Assemblies
Certifications	<ul style="list-style-type: none"> ISO 9001: 2015 ITAR

Markets Served

- Agriculture
- Appliances
- Construction
- Consumer Electronics
- Consumer Products
- Distribution
- Heavy Truck
- Tiered Automotive
- Industrial
- Lawn & Garden
- Off-Road & Emergency Vehicles
- Oil, Gas, & Energy

Get In Touch

To order stock or custom parts, visit MWComponents.com/Hi-Performance or contact us at 630.860.7766 | hpssales@mwcomponents.com

Holbrook Manufacturing

High-Quality & High-Volume Fasteners

- #2 – ½" & M2 – M12 Diameters
- Licensed Products
- Quick Turnaround
- ISO 9001 Certified





Holbrook Manufacturing Process Capabilities

Products	<ul style="list-style-type: none">• Bolts• Screws• Cold Formed Pins	<ul style="list-style-type: none">• Studs• Licensed Products
Diameters	<ul style="list-style-type: none">• #2 - 1/2"	<ul style="list-style-type: none">• 2mm - 12mm
Lengths	<ul style="list-style-type: none">• Up to 4"	<ul style="list-style-type: none">• 5mm – 101mm
Materials	<ul style="list-style-type: none">• Alloy Steel• Aluminum• Brass• Low Carbon Steel	<ul style="list-style-type: none">• Medium Carbon Steel• Silicon Bronze• 300 Series Stainless• 400 Series Stainless
Finishes	<ul style="list-style-type: none">• Heat Treating• Passivation• Organic Plating	<ul style="list-style-type: none">• Trivalent Zinc• Black Oxide• Zinc Phosphate
Manufacturing Services	<ul style="list-style-type: none">• Assembly• Bagging• Deburring• Drilling• End Slotting	<ul style="list-style-type: none">• Kitting• Patching• Rotary & Centerless Grinding• Shaving• Sorting
Certifications	<ul style="list-style-type: none">• ISO 9001:2015 Certified	

Markets Served

- Agriculture & Turf
- Automotive
- Construction
- Energy
- Engine Aftermarket
- Furniture
- HVAC
- Industrial
- Machinery
- Medical
- Metalworking
- Plumbing

Get In Touch

To order stock or custom parts, visit mwcomponents.com or contact us at sales@mwcomponents.com

➤ Ideal Fasteners

Delivering Quality, Reliability & Service For Over 50 Years

- Licensed Manufacturer Of TORX®, TORX Plus®, & TORQ-SET®
- NAS / MS Fasteners
- Fast Delivery Of Standard Stock & Custom Parts
- High Volume Capabilities
- ISO 9001, AS9100 & QSLM Certified



Ideal Fasteners Process Capabilities

Diameters	<ul style="list-style-type: none"> • 00-90 Diameter to ½ (.500) Diameter • M1.0 to M12 Diameter
Lengths	<ul style="list-style-type: none"> • #0 - #1 Diameter (up to 1.5 inch) • #2 - #3 Diameter (up to 3 inch) • #4 - ¼ Diameter (up to 7 inch) • 5/16 - ½ Diameter (up to 4 inch) • M1.0- M2.0 (up to 38 mm) • M2.2 - M2.5 (up to 76 mm) • M3 - M6 (up to 175 mm) • M8 - M12 (up to 100 mm)
Materials	<p>Stainless Steel</p> <ul style="list-style-type: none"> • 302hq (UNS S30430)/S30433 • 316/316L (UNSS31600/S31603) • 304/304L (UNS S30400/S30403) <p>Alloy Steel</p> <ul style="list-style-type: none"> • 8740 (UNS G87400) • 4037 (UNS G40370)
Specialty Materials	<ul style="list-style-type: none"> • 410 (UNS S41000) • A286 (UNS S66286) • Monel 400 / K500 (UNSN04400/N05500) • 17.4PH (UNS 17400) • Aluminum 2024 / 6061 / 7075 • Brass (70/30) • Inconel 718 (UNS N07718)
Manufacturing Services	<ul style="list-style-type: none"> • Machining • Cold Forming • Coatings & Surface Treatments • Component Sourcing & Supply • Performance Analysis & Testing • Quick Turnaround Service/JIT Delivery • Prototyping & Rapid Prototyping • Drilling • Mag Particle/Magnafluxing • Laser Engraving
Certifications	<ul style="list-style-type: none"> • AS9100D • ISO 9001 • NADCAP Accredited • QSLM Class 2&3 • FQA Compliant • ANAB Accredited

Markets Served

- Aerospace
- Defense
- Medical
- Commercial

Get In Touch

To order stock or custom parts, visit idealfasteners.com or contact us at 714.630.7840 | sales@mwcomponents.com

➤ Ohio Rod Products

Narrow-Diameter & Long-Length Fasteners

- Diameters Through 5/8"
- Lengths Up to 86"
- Quick Turnaround
- ISO 9001 & FQA Compliant
- Accredited ISO 7025/A2LA Testing Laboratory



Ohio Rod Products Process Capabilities

Products	<ul style="list-style-type: none"> All Thread Rods Bolts Screws 	<ul style="list-style-type: none"> Rivets Studs Washers 	<ul style="list-style-type: none"> Cold Formed Pins Licensed Products
Diameters	<ul style="list-style-type: none"> #2 Diameter to 5/8" Diameter 		<ul style="list-style-type: none"> M2.5 to M16 Diameter
Lengths	<ul style="list-style-type: none"> 2.85" – 86" 		<ul style="list-style-type: none"> 73 – 24.38.4mm
Materials	<ul style="list-style-type: none"> Low Carbon Steel Bronze Brass 	<ul style="list-style-type: none"> Aluminum 6061 Aluminum 5056 Stainless: 302, 304, 401 	
Finishes	<ul style="list-style-type: none"> Pre-Galvanized Hot Dip Galvanized Zinc – Clear Trivalent Zinc – Yellow Trivalent Wax Zinc Nickel Clear Zinc Nickel Black Zinc Olive Green 	<ul style="list-style-type: none"> E-Coat Dry Phosphate Wash Iron Phosphate Tumble Organic Phosphate Passivation Phosphate & Oil Phosphate & Wax Patches Black Oxide & Magnigard 	
Manufacturing Services	<ul style="list-style-type: none"> Rolling Extruding Chamfering Slotting Knurling Pointing 	<ul style="list-style-type: none"> Drilling Bending Winging Plating Lathe Shaving 	<ul style="list-style-type: none"> Case Hardening Roll Chamfering Heat Treating Plating Packaging Trimming Stocking CNC milling
Certifications	<ul style="list-style-type: none"> ISO 9001 FQA Compliant Fasteners 		<ul style="list-style-type: none"> Accredited ISO 7025/A2LA Testing Laboratory

Markets Served

- Agriculture
- Construction
- Medical
- Appliances
- Conveyors
- Military
- Automotive
- Electric Motors & Pumps
- Shipbuilding
- Cable & Wire Reels
- Energy
- Recreation
- Compressors
- Lawn & Garden

Get In Touch

To order stock or custom parts, visit ohiorod.com or contact us at sales@mwcomponents.com

➤ RAF Electronic Hardware

Electronic Hardware & CNC Precision Turned Components

- Stock Parts Ship Same Day
- Fast Delivery Of Custom Parts
- NAS Fasteners & Hardware
- Small Minimum Order Quantities
- High Volume Capabilities
- ISO 9001 Certified

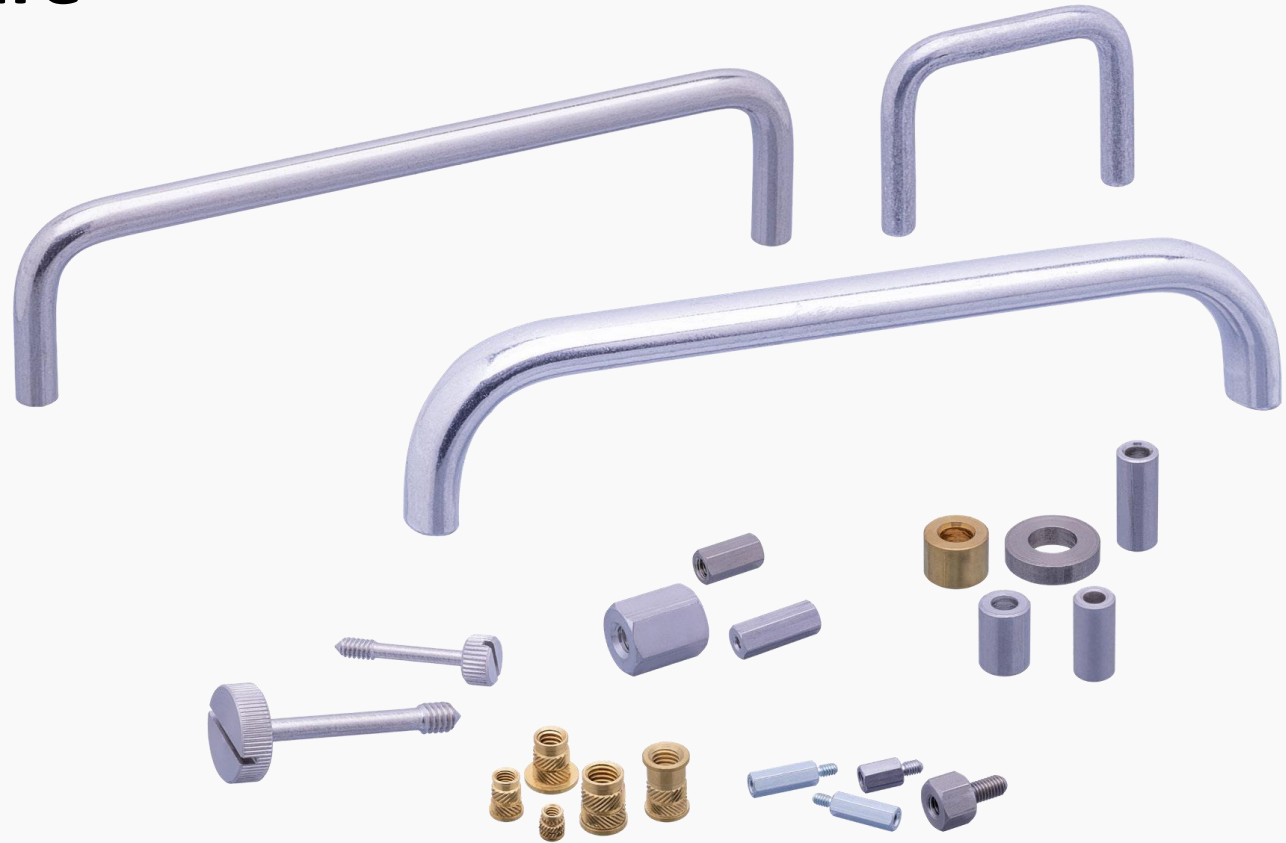

▶ RAF Electronic Hardware Products

Captive Panel Screws



Spacers



Standoffs

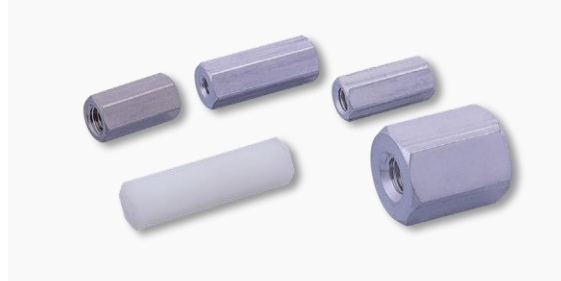

Jack Screws



Precision Shoulder Screws



Thumb Screws



Male-Female Standoffs

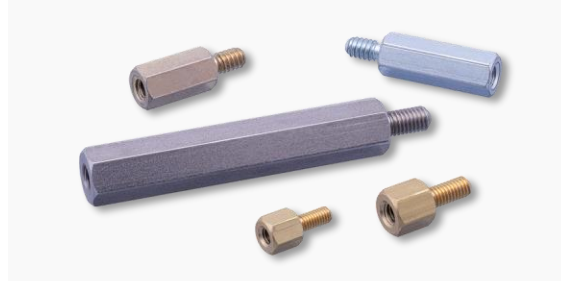

Handles & Ferrules

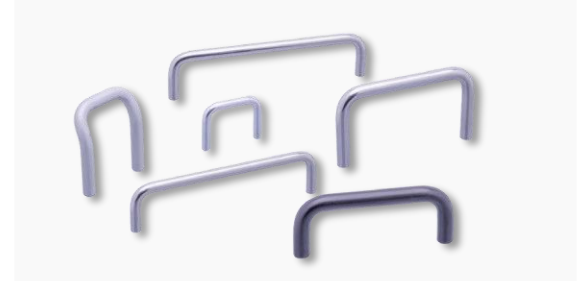

Threaded Inserts



NAS Fasteners



CNC Precision Machined Parts



Custom Design Products





RAF Electronic Hardware Process Capabilities

Diameters	<ul style="list-style-type: none"> • Stock Parts in US and Metric • Custom Parts .020 – 1”
Lengths	<ul style="list-style-type: none"> • Stock Parts in US and Metric • Custom Parts Up to 4”
Materials	<ul style="list-style-type: none"> • A286, Stainless Steels, Aluminum, Brass, High Nickel Alloys, Super Alloys, Beryllium Copper, Steel, Exotics Alloys, Nylon, Delrin, Ultem, Plastics, Titanium
Threads	<ul style="list-style-type: none"> • Customizable to All Machined Thread Sizes Both US and Metric
Finishes & Platings	<ul style="list-style-type: none"> • 48 Finishes Available • Passivation • Anodized • Cadmium • Chromium • Nickel • Brushed Finishes • Tin • Zinc • Black Ox • Chem-Film
Locking Devices	<ul style="list-style-type: none"> • ND Patch • ND Vibra-Tite • ND Pell-It • 360 Ring Patch • Microspheres • Custom Applications
Manufacturing Processes	<ul style="list-style-type: none"> • CNC Machining • CNC Swiss Turn • Tapping • Multi Spindle Automatics • Assembly • Micro Machining
Additional Processes	<ul style="list-style-type: none"> • In House Plating • Heat Treat • Secondary Operations • Knurling
Certifications	<ul style="list-style-type: none"> • ISO 9001:2015 • ITAR • DFARS • REACH • RoHS • MIL-I-45208A

Markets Served

- Electronics
- Commercial
- Hardware
- Defense/Aero
- Fiber Optics
- RF/Microwave
- Medical

Get In Touch

To order stock or custom parts, visit rafhdwe.com or contact us at 203.888.2133 | info@rafhdwe.com

Rockford Fastener

Mission Critical Large & Small-Diameter Fasteners

- .090" – ½" & M3 – M12 Diameters
- NAS Fasteners
- Licensed Products
- Quick Turnaround
- ISO 9001 Certified



Rockford Fastener Process Capabilities

Products	<ul style="list-style-type: none"> • Bolts • Screws • NAS Fasteners 	<ul style="list-style-type: none"> • Studs • Locking Fasteners • Licensed Products 		
Diameters	<ul style="list-style-type: none"> • #4 - ½" 	<ul style="list-style-type: none"> • 3mm - 12mm 		
Lengths	<ul style="list-style-type: none"> • 3/16" – 5" 	<ul style="list-style-type: none"> • 5mm – 127mm 		
Materials	<ul style="list-style-type: none"> • 1010, 1022, and 4037 Steel • 10821 Carbon Steel • CDA 260 Brass • 651 Silicon Bronze 	<ul style="list-style-type: none"> • 410 and 430 Stainless Steel • 302 HQ Stainless Steel • Alloy 4037 • Alloy Steel • Aluminum 	<ul style="list-style-type: none"> • Boron 10B21 • Low Carbon 1006 • Low Carbon 1008 • 1010 Low Carbon 	<ul style="list-style-type: none"> • 1022 Medium Carbon 1038
Finishes	<ul style="list-style-type: none"> • Zinc – Bright • Zinc – Chromate • Zinc – Plated • Zinc – Yellow • Zinc – Trivalent Yellow 	<ul style="list-style-type: none"> • Zinc – Black • Zinc – Trivalent Black • Magnesium Phosphate & Oil • Phosphate & Wax Clean • Clean & Oil 		
Manufacturing Services	<ul style="list-style-type: none"> • Shank Slotting • Nylon / Scotch Grip Patch 	<ul style="list-style-type: none"> • Kitting • Head Slotting • Heat Treating 	<ul style="list-style-type: none"> • Magni Finish • Threading • Cleaning 	<ul style="list-style-type: none"> • Heading • Sorting • Plating
Certifications	<ul style="list-style-type: none"> • ISO 9001:2015 Certified • PAPP & ISIR Documentation 	<ul style="list-style-type: none"> • Accredited ISO 7025/A2LA Testing Laboratory 		

Markets Served

- Agriculture & Turf
- Appliance
- Automotive
- Construction
- Energy
- Engine Aftermarket
- Electric Motors & Pumps
- Heavy Equipment
- Industrial
- Lawn & Garden
- Material Handling
- Power Generation
- Shipbuilding

Get In Touch

To order stock or custom parts, visit mwcomponents.com or contact us at sales@mwcomponents.com

Sussex Wire

High-Precision Standard & Custom Micro Components

- Highly Engineered, Specialty Metal Parts And Components
- Fast Delivery Of Custom Parts
- Production Runs Up To 500+ Million Components
- JIT Kanban Inventory Management Capabilities
- ISO 9001 Certified

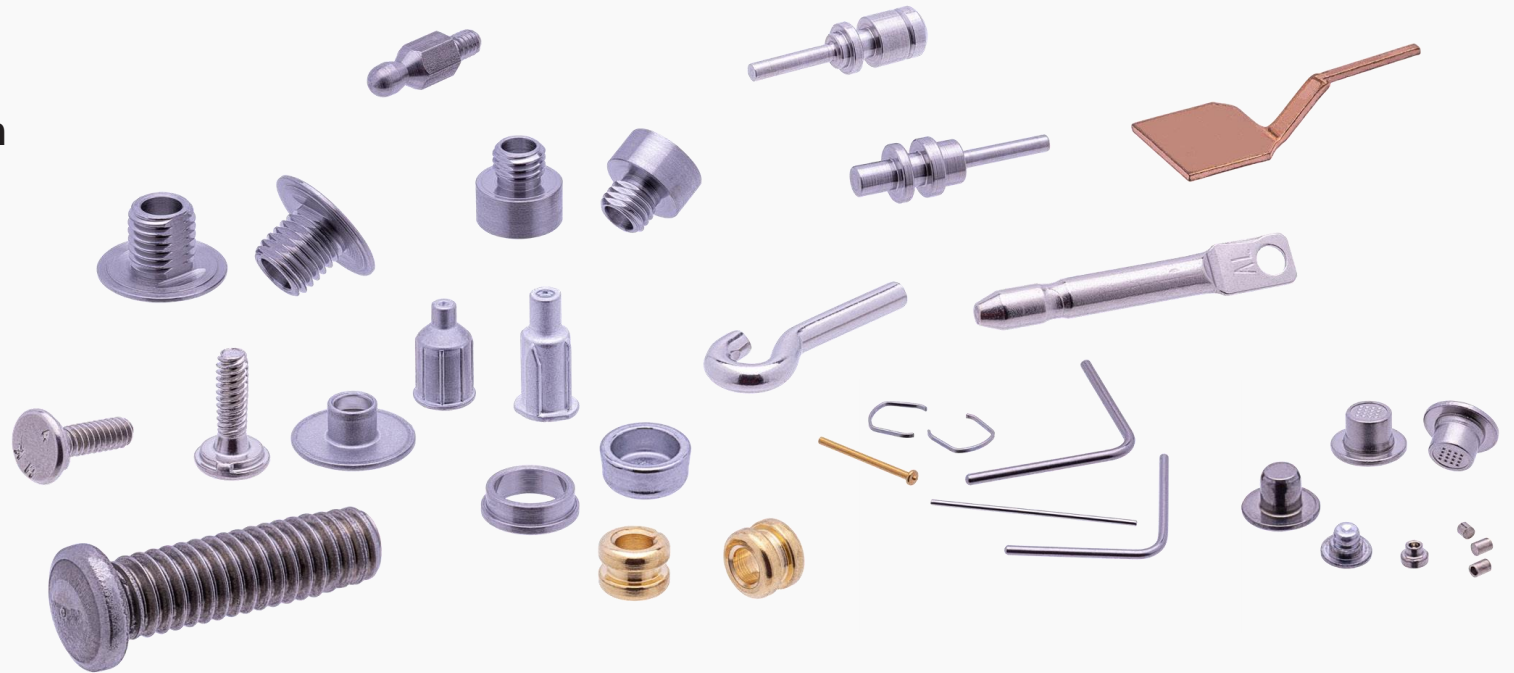

Sussex Wire Products

Single & Multi-Thread Pins & Leads



Wire Forms



Custom Screw Machined Products

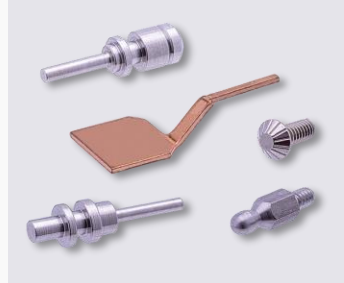

Cold Heading



Roll Forming



Pointing & Tapping



Coiling & Stamping



Eyelet & O-Rings



Caps & Buttons



Hubs & Inserts



Valves



Connectors





Sussex Wire Process Capabilities

Diameters	<ul style="list-style-type: none"> • .0035" to .400"
Lengths	<ul style="list-style-type: none"> • Available in all types of lengths both US and Metric
Materials	<ul style="list-style-type: none"> • Various Alloys, Aluminum, Copper, Copper Alloys, Copper Cored, Copper Clad, Inconel, Nickel Alloys, Platinum, Steel, and Stainless Steel
Dimensioning & Tolerancing	<ul style="list-style-type: none"> • AOI, RAM Optical Metrology, Micrometers, Optical Comparators, Drop Gages, Pin Gages, Vernier, 100% Inspection Capabilities
Manufacturing Services	<ul style="list-style-type: none"> • Cold Forming • CNC Swiss Micro-Machining • Roll Forming • Threading • Tapping • Turning • Pointing • Electrical Discharge Machining (EDM) • Cleaning • Tumbling • Etching • Plating
Certifications	<ul style="list-style-type: none"> • ISO 9001:2008 • ITAR • NIST Traceability • REACH • DFARS • RoHS • AMS

Markets Served

- Automotive
- Electric Vehicles
- Defense
- Electronics
- Energy, Oil, & Gas
- Medical
- Semiconductor
- Transportation

Get In Touch

To order stock or custom parts, visit sussexwire.com or contact us at 610.250.7750 | info@mwcomponents.com

Telefast Industries

Custom Cold Formed Fasteners

- Threaded Fasteners For Internal Applications
- Custom Long & Large Bolts
- Standard Sizes In Stock
- Quick Turnaround
- ISO 9001 Certified, QSLM Class 2 & ITAR Compliant



Telefast Industries Process Capabilities By Product Type

	Internally Threaded Fasteners	Externally Threaded Fasteners
Products	<ul style="list-style-type: none"> Flange Nuts All Metal Lock Nuts Jam Hex Nuts Square Nuts Round Nuts 	<ul style="list-style-type: none"> Bolts Screws Cold Formed Pins
Diameters	<ul style="list-style-type: none"> ¼" – 7/8" (M6-M20) 	<ul style="list-style-type: none"> 5/16" – 5/8" (M8-M16)
Lengths		<ul style="list-style-type: none"> ½" – 11 ½" (13-292mm)
Materials	<ul style="list-style-type: none"> CHQ Steel: 4140, 4037, 302HQ & 316HQ Carbon Steel Alloy Steel Stainless Steel Brass Aluminum 	<ul style="list-style-type: none"> Low Carbon 1008-1022 Medium Carbon 1038 B16 (AMS 6304) Alloy 4037, 4140/4142, 8620/8640, 8740 & 5135 Stainless 302/304 CHQ Precipitation A286 Carbon Steel 1045 & 1541 Boron 10B21 Brass
Finishes	<ul style="list-style-type: none"> Zinc with Clear or Colored Chromate Cadmium with Clear or Colored Phos & Oil Metallic Silver Organic Coatings Hot Dip Galvanized & Mechanically Galvanized Delta Blue Zinc Nickel 	<ul style="list-style-type: none"> Sharperize Zinc – Clear, Yellow, Trivalent Yellow, Black, Trivalent Black Nickel Stripping Zinc Iron Silver Black Oxide Passivate Magni Zinklad 1000 CARC Copper Gleitmo 603 Sealer Phos & Oil Clean & Oil Delta Protekt Electro Polyseal Manganese Nickel Zinc Dacromet & More
Manufacturing Services	<ul style="list-style-type: none"> Tapping Top Lock & Side Lock Slotting Packaging Deflection – top and side lock 	<ul style="list-style-type: none"> Box Milling Broaching Drilling Face Cut Grinding Knurling Pointing Rolling Trimming Shaving Slotting Turning
Certifications	<ul style="list-style-type: none"> ISO 9001:2015 Certified 	<ul style="list-style-type: none"> QSLM Class 2 ITAR Compliant

Markets Served

- Automotive Aftermarket
- Construction & Infrastructure
- Energy
- Heavy Equipment
- Distribution
- Military
- Motorsports
- Non-Automotive Ground Transport

Get In Touch

To order stock or custom parts, visit mwcomponents.com or contact us at fastenerquotes@mwcomponents.com

USA Fastener

USA Fastener is a recognized leader in the fastener industry, offering quality fasteners and assemblies.

- Stocked Parts Ship in 24 Hours
- Custom Studs, Nuts, Bolts, Sockets & More
- Standard & Exotic Materials
- Many Coating & Plating Options
- ISO 9001 Certified
- API 20E BSL 1, 2 & 3 Certified
- API SPEC Q1 Certified

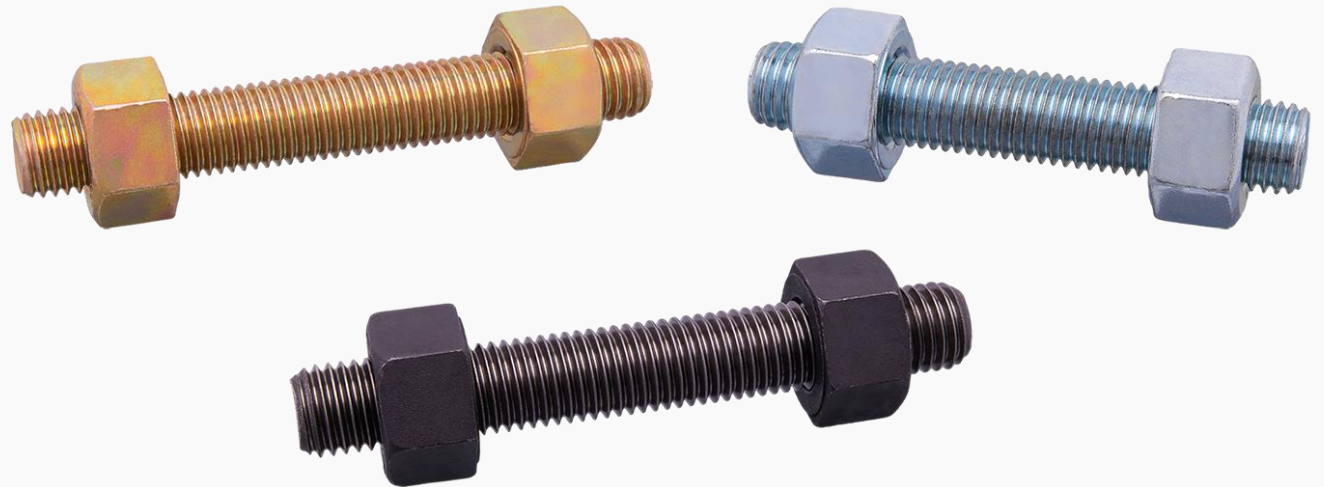

USA Fastener Products

Studs & Nuts

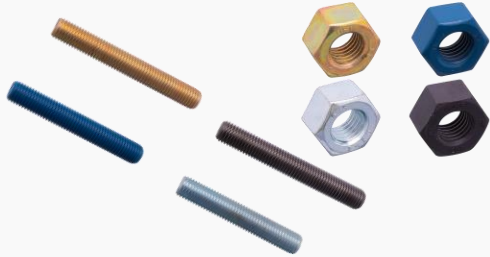

Assemblies

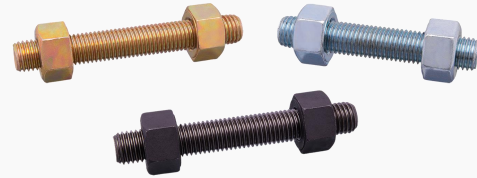

12-Point Cap Screws



Hex Head Bolts

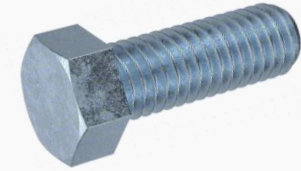

B7 Stud & 2H Nut Assemblies



Sockets



Raw Materials



Custom Fasteners

Custom fasteners of most diameters and lengths can be made to order.

All Products

All Thread Studs
 Stud & Nut Assemblies
 Double End Studs
 Tap End Studs
 Single End Studs
 Tapered Studs

Collar Studs
 Combination Studs
 Finished & Heavy Pattern Nuts & Bolts
 Tommy Nuts
 12-Point Nuts & Screws
 Hex Head Bolts & Tap Bolts

Socket Head Cap Screws
 Set Screws
 Shoulder Bolts
 Round Bar & All Thread



USA Fastener Process Capabilities

Diameters & Lengths (Hot Forging)	<ul style="list-style-type: none"> • Diameters ½" - 7/8" - Lengths Up To 14" • Diameters 1" - 3" - Lengths Up To 24"
Fastener Configurations	<ul style="list-style-type: none"> • Finished Hex Head Bolts / Heavy Hex Head Bolts • Flange Bolts • Socket Head Cap Screws • Finished Hex Nuts / Heavy Hex Nuts • Fasteners – Per Print
Materials	<ul style="list-style-type: none"> • Various Alloys, Carbon Steel, Stainless Steel, Copper Alloys, Nickel Alloys, Exotics
Finishes	<ul style="list-style-type: none"> • Xylan, FluoroKote, SermaGard, GEOMET, NanoGalv, Moly, Black Oxide, Phosphate, Zinc (clear or yellow), CAD (clear or yellow), Hot-dip Galvanizing, Others as Requested
Manufacturing Services	<ul style="list-style-type: none"> • CNC & Lathe • Cutting • Chamfering • Tapping • Milling • Plating • Hot Forging • Drilling • Threading • Cut Thread Up To 4" • Rolled Thread Up To 1 ½" • Assembly • Sawing Up To 14" Dia. • In-house Material Testing
Certifications	<ul style="list-style-type: none"> • ISO 9001 • API 20E BSL 1, 2, & 3 • API SPEC Q1

Markets Served

- Energy
- Oil & Gas
- Valves & Actuators

Get In Touch

To order stock or custom parts, visit usa-fastener.com or contact us at 713.641.4600 | usasales@usa-fastener.com

➤ Western Wire Products

Your #1 Source for Wire Fasteners and Wire Forms

- Ready-to-Ship Stock Parts
- Rapid Custom Build-to-Order
- Flexible Minimum Order Quantities
- Fast Delivery Of Custom Parts
- Precision Wire Forming for Simple and Complex Shapes
- ISO 9001 Certified, USA Made
- Custom Inventory Programs & Blanket Orders

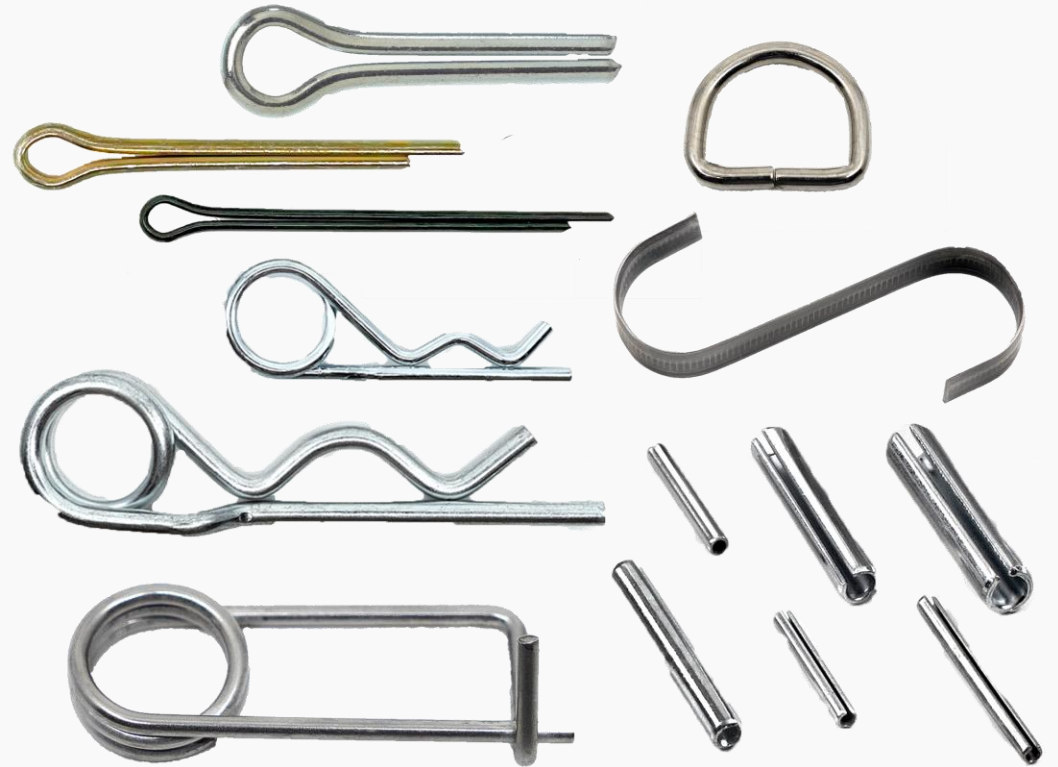

Western Wire Products

Cotter Pins



D Rings



S Hooks



Hitch Pin Clips

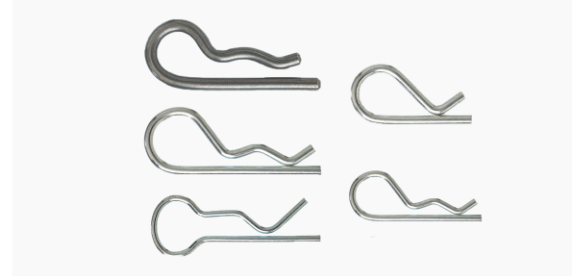

Hog Rings



Spring Pins



Other Standard Wire Fasteners

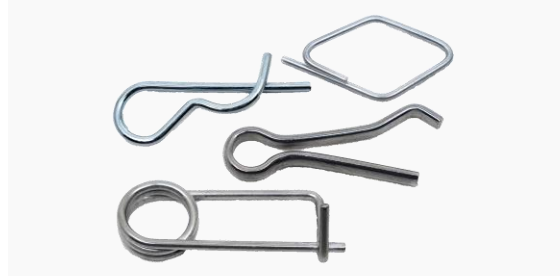

Custom Wire Forms

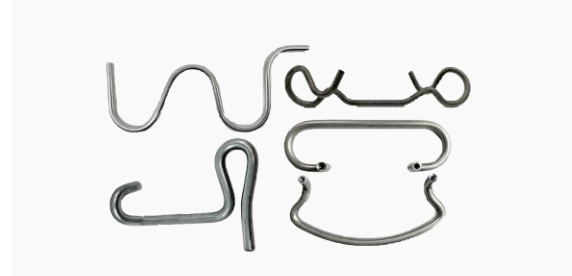

Custom Wire Forming

Western Wire is an industry leader in custom wire forming, with the ability to offer everything from simple parts to extremely complex shapes. Our wide array of equipment and processes allow for the fabrication of complex wire forms in small to large quantities at competitive prices. Get everything from a few pieces or prototypes to high volume manufacturing.



Western Wire Process Capabilities

Diameters	<ul style="list-style-type: none"> • .010" to .625" or .25mm to 16mm 	
Lengths	<ul style="list-style-type: none"> • Nearly unlimited blank length 	
Materials	<ul style="list-style-type: none"> • Stainless Steel – all grades, Low Carbon Steel, High Carbon Steel, Monel, Aluminum, Brass, Copper, Exotics 	
Finishes	<ul style="list-style-type: none"> • Passivation • Black Oxide • Electropolish 	<ul style="list-style-type: none"> • Powder Coating • Phosphate & Oil
Plating	<ul style="list-style-type: none"> • Cadmium • Chromium • Nickel 	<ul style="list-style-type: none"> • Silver • Tin • Zinc
Manufacturing Processes	<ul style="list-style-type: none"> • CNC Wire Forming • Multi-Slide Manufacturing • Threading • Deburring • Staking • Stamping 	<ul style="list-style-type: none"> • Milling • Drilling • Undercutting • Tapping • Welding
Additional Processes	<ul style="list-style-type: none"> • Heat Treat • PPAP/FAIR 	<ul style="list-style-type: none"> • Assembly
Certifications	<ul style="list-style-type: none"> • ISO 9001:2015 • DFARS • REACH 	<ul style="list-style-type: none"> • RoHS Cage Code: 65029 • Unique Entity ID (UEI): Available on SAM.gov

Markets Served

- Aerospace
- Agriculture
- Electrical
- Plumbing
- Industrial
- Commercial

Get In Touch

To order stock or custom parts, visit westernwireprod.com or contact us at 800.325.3770 | sales@westernwireusa.com



Thank you!

For Quoting & Additional Information,
Contact Us At sales@mwcomponents.com



MW Components